

GS11 - Non-Structural Seismic Bracing



Our Seismic Bracing Systems are designed and engineered to brace suspended non-structural equipment and components to minimize damage from an earthquake or seismic event.

FEATURES & BENEFITS

- Tested according to the following standards:
 - ANSI/ASHRAE Standard 171-2017 - Method Of Testing For Rating Seismic And Wind Restraints
 - AC156 - Seismic Certification by Shake-table Testing of Nonstructural Components
 - AS/NZS 1170.0 - Structural design actions - General principles
- Complete pre-engineered systems - full range of product & engineering services available to ensure the most efficient, cost effective bracing solutions
- No field swaging - consistent quality and no tools required to install
- Colour coded kits - easy field identification/inspection verification
- Adaptable kits - suitable for use in a variety of configurations



PRODUCT CODE BUILDER

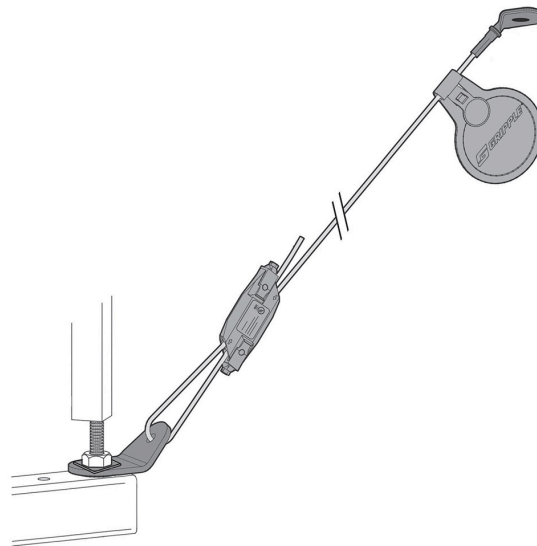

Wire Size:		Cable Length (m):		End Fitting:	Loose Bracket:	Anchor Size:
GS11	-	3M	-	E	H	8
GS11	-	3M	-	V	H	8
GS11	-	3M	-	E	T	8
GS11	-	3M	-	V	T	8
GS11 = 3mm		3m as standard. Custom lengths available.		E = 45° Eyelet with an 10mm hole size. V = V-Bracket with a hole for an 8mm anchor	H = Retrofit bracket. T = Standard bracket.	M8 Anchor supplied as standard.



GS11 - Non-Structural Seismic Bracing



Our Seismic Bracing Systems are designed and engineered to brace suspended non-structural equipment and components to minimize damage from an earthquake or seismic event.

PRODUCT INFORMATION

Wire Size: 3mm pre-stretched wire rope

ULS Rating as per AS/NZS1170.0: 220 kg*

* Bracket and anchor selection will determine actual load rating. Brace methodology must be specified by a Professional Engineer.

Supplied: As ready to install kits including a Gripple Lockable Fastener, a length of pre-stretched wire rope (3 m, 6 m, or 9 m), end fitting and loose bracket as specified and a colour coded identification tag

Standards & Compliance: AS1170.4, NZS1170.5, NZS4219, SMACNA, OSHPD, UL NEBS

INSTALLATION GUIDELINES

1. Attach loose bracket

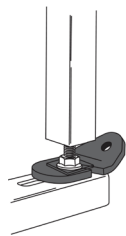

2. Install anchor and attach swaged bracket

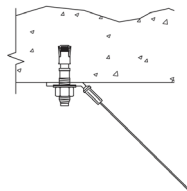

3. Insert wire rope into Gripple Lockable Fastener

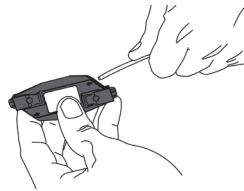

1. Attach loose brackets to non-structural component
2. Secure end fixing to structure
3. Insert wire rope through one channel of the Gripple Lockable Fastener
4. Thread the wire rope through the hole of the seismic bracket
5. Thread wire rope back through the Gripple Lockable Fastener and hand tighten to remove all slack
6. Hand-tighten the locking bolts until secure

4. Feed wire rope through loose bracket

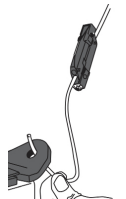

5. Feed wire rope through the second channel in Gripple Lockable Fastener

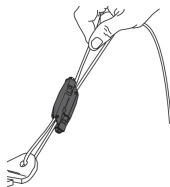

6. Lock Gripple fastener

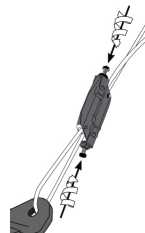

Images shown are examples of a typical installation. Specifics can vary between installations.

SYSTEM COMPONENTS



Gripple Lockable Fastener

Identification tag on wire rope

Choice of brackets

Anchor Options

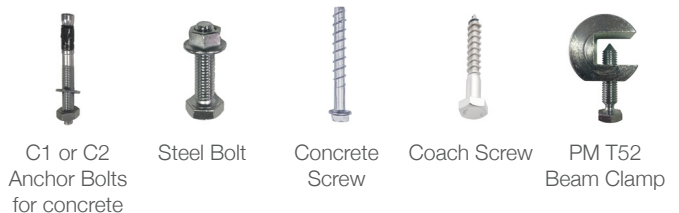

C1 or C2 Anchor Bolts for concrete

Steel Bolt

Concrete Screw

Coach Screw

PM T52 Beam Clamp

